

IONIC®

ADVANCED FLEXIBLE SOLUTIONS

DYNAMIC

IONIC designs, manufactures and distributes innovative advanced flexible solutions for LCD and Plasma screens. Our range consists out of high-end mounting brackets, flexible cable management and storage possibilities for peripherals. Top design and functionality are binding assets of our products.

Our mission is to improve space around LCD and plasma televisions and workstations by adding design and comfort. Targeted end-users use our products in their residential houses, but also see them in offices, retail and service providers, all over the world.

IONIC focuses on design, innovation and marketing. Production and logistics are outsourced. In this way the beginning of the product chain, the birth of a product, gets our full attention. All aspects will be considered and not even a small detail will be forgotten.

IONIC is an international oriented company, its production takes place in China. Customers will be serviced from warehouses in Panyue in China, Nieuwegein in The Netherlands and Zeeland (Michigan) in the USA.

IONIC products have outstanding design; function better as competitive products and are still being sold at equal prices. Together with our high standard after-sales procedure and reliable delivery performances, we offer the pure basis for a good relationship.

Our client is put on top of the scheme. This means we will do our utmost to satisfy the client. Our product has to be of high quality as well as our service towards clients.

IONIC BV

GELDERLANDHAVEN 2T
NL-3433 PG NIEUWEGEIN
INTERNET WWW.IONIC.NL
PHONE +31 (0)30 600 61 00

DYNAMIC LUNA 100



DYNAMIC LUNA100



25KG



75&100



UPTO 26"

Distance from wall 8,8 cm

Rotating 360°

Tilting 15° up & 15° down

Swivel 95°

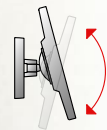

SIDEVIEW

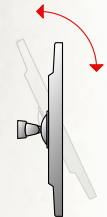

TOPVIEW

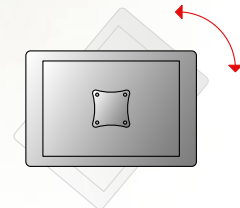

FRONTVIEW

DYNAMIC LUNA 101



DYNAMIC LUNA101



18KG



75&100



UPTO 26"

Distance from wall8,8 to 26,8 cm

Rotating 360°

Tilting 15° up & 15° down

Swivel 95°

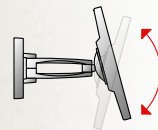

SIDEVIEW

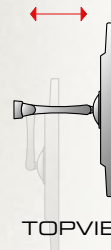

TOPVIEW

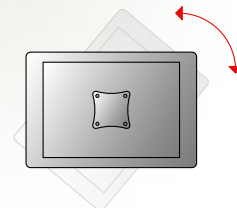

FRONTVIEW

DYNAMIC LUNA 102



DYNAMIC LUNA 102



15KG



75&100



UPTO 26"

Distance from wall8,8 to 44,8 cm

Rotating 360°

Tilting 15° up & 15° down

Swivel 95°

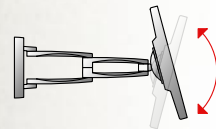

SIDEVIEW

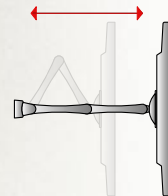

TOPVIEW

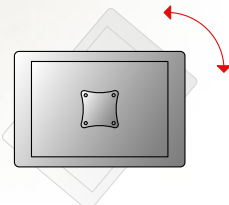

FRONTVIEW

CEILING ZOOM M102

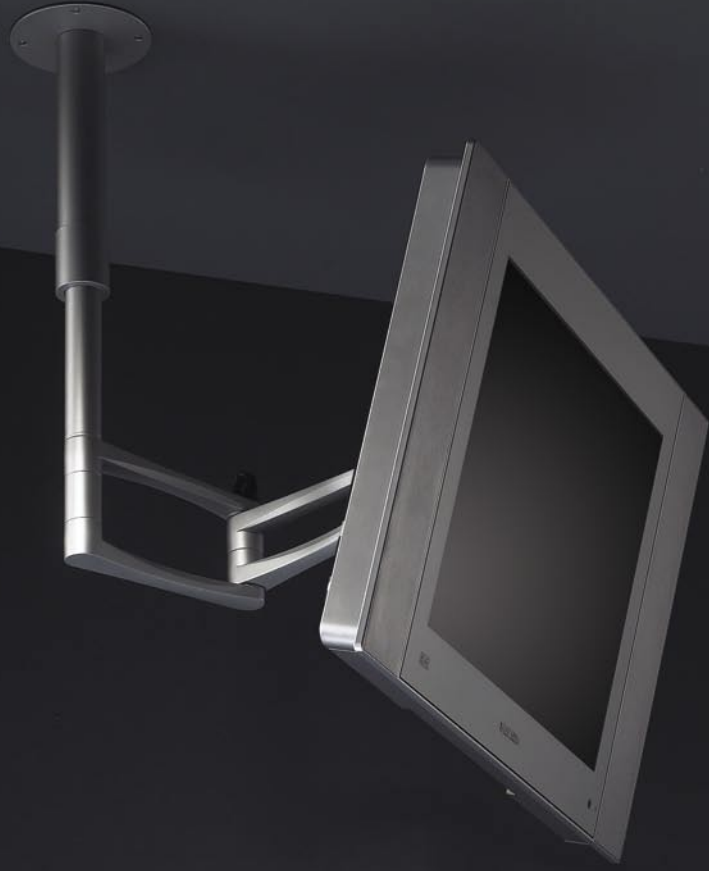

CEILING ZOOM1102

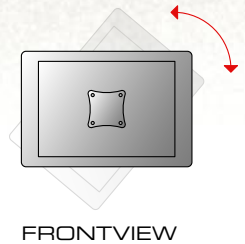
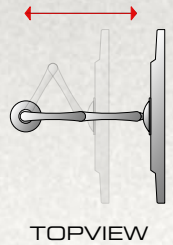
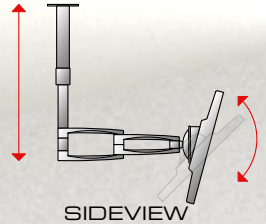
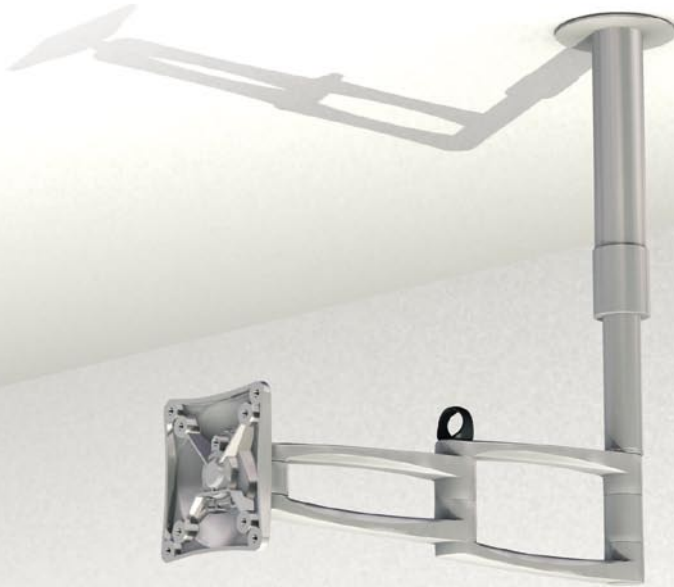

15KG



75&100



26"

Adjustable height30 to 42 cm

Rotating 360°

Tilting 0 to -30°

Swivel 95°

DYNAMIC SYNCHRO



DYNAMIC SYNCHRO

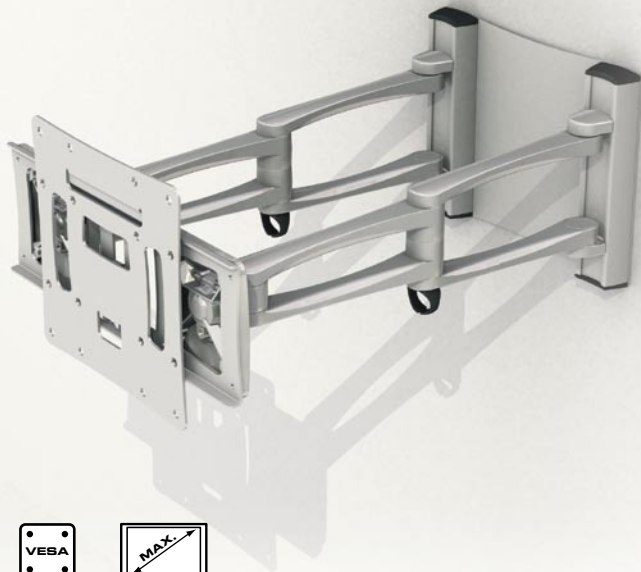

30KG



100&200



26"

VESA 100X100 / 200X200

. 100X200 / 200X100

Distance from wall 8,8 to 52 cm

Tilting 15° up & 15° down

Swivel 80°

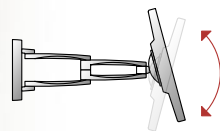

SIDEVIEW

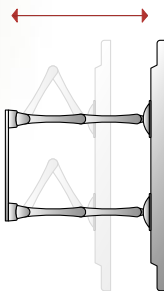

TOPVIEW